

BASES 84 & LONGER

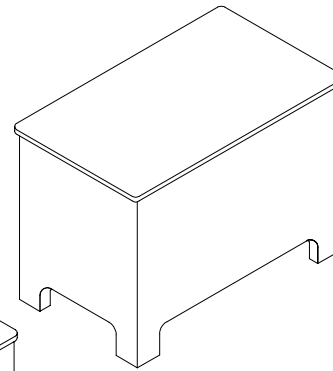

BASES UP TO 84 LONG

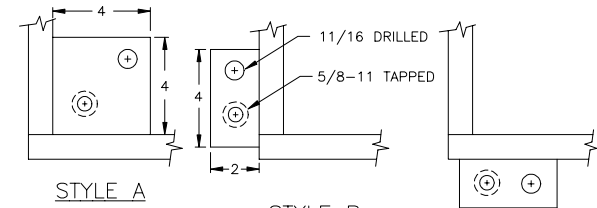
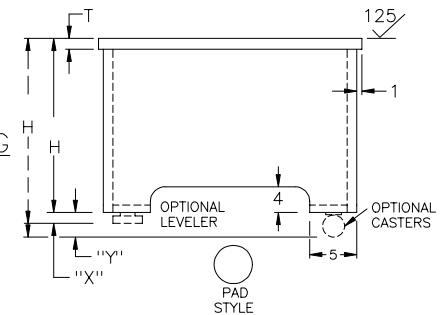
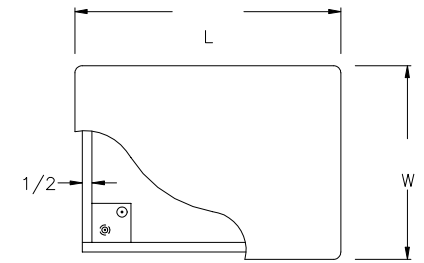

STYLE A

ALL PADS ARE
3/4" THICK

STYLE B

PAD STYLES

STYLE C

OPTIONS

- COOLANT TROUGH
SPECIFY SIZE (1 1/2 DEEP X3, 2 1/2 DEEP X4, 4 DEEP X4) _____
- COOLANT TROUGH DRAIN (1 1/2 COUPLING) (SPECIFY LOCATION)
- BOLTED TOP PLATE
- TOP BURNOUTS PER DRAWINGS # _____
- STANDARD VIBRATION DAMPENING LEVELING PAD (X=2 7/8)
- HEAVY DUTY, ALL STEEL LEVELING PAD (X=2 1/2)
- BC-1 LOCKING CASTERS (4" DIAMETER) (Y=5 3/8)
- BC-2 LOCKING CASTERS (6" DIAMETER) (Y=7 1/2)
- FRAME ONLY - SPECIFY SIZE _____
- MATTISON GRIND TOP - 63 MICRO OR BETTER
- FREE MACHINING STEEL TOP
- CAST ALUMINUM TOOL & JIG PLATE TOP
- 304 STAINLESS STEEL TOP
- MACHINE PER DRAWING # _____
- BLACK OXIDE BOLT ON TOP
- ANODIZE ALUMINUM TOP
- PAINT GREEN LACQUER PRIMER
- PAINT FEDERAL SAFETY BLUE ENAMEL
- CUSTOM PAINT - SPECIFY _____

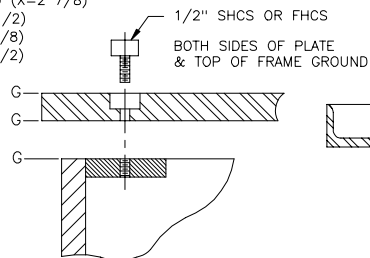

BOLT ON TOP

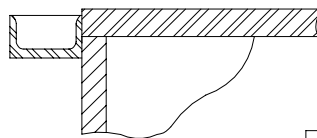

COOLANT TROUGH

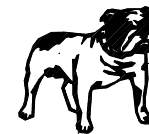

BRUTE MACHINE BASES®

2000 N. MANGO AVE. CHICAGO, IL. 60639-2899
(773) 889-4343 FAX: (773) 889-3781
Outside Illinois call Toll Free (877) 988-4343

STANDARD SPECIFICATIONS

- A36 STEEL
- ALL WELDED CONSTRUCTION
- SHOT BLAST & PAINT GRAY ENAMEL
- BLANCHARD GRIND TOP CLEANUP

MODEL 400

ENGINEER

DATE

DRAWING No. REV-2

CUSTOMER NAME